

ITALIAN FRAME

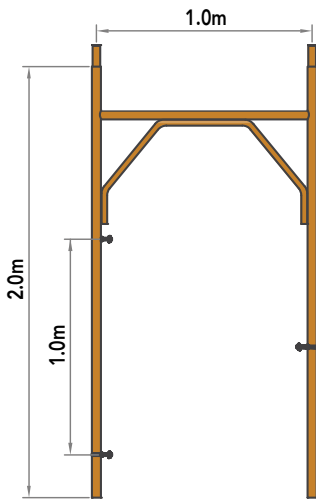

DOUBLE LADDER FRAME

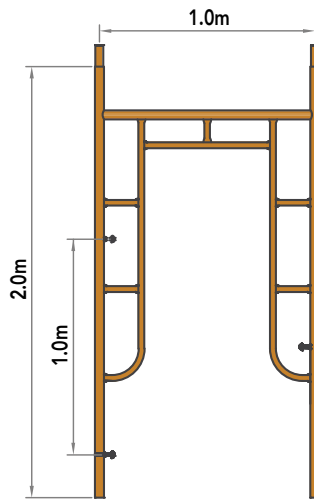

SINGLE LADDER FRAME

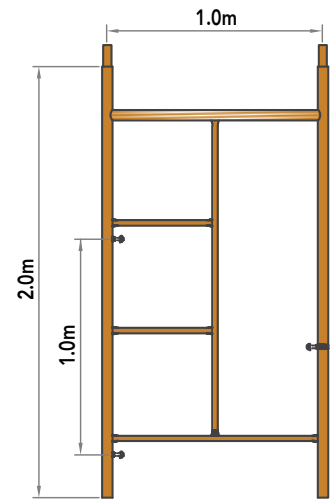

VERTICAL TUBES OF THE FRAME ARE MADE OF Ø48.3X2MM TUBE

KHK high quality external system is designed to be easy to erect & dismantle without help from professionals. The 'H' Frame, (or) vertical member, has a welded square (or) round pin on top for ease of connection. This allows you to erect the frames faster and to any height with maximum safety & stability. The system is designed not to include any loose fittings inside. The access frame system comes in six different forms all of which conform with British, Italian, Spanish & Korean standards. Non-standard sizes are available by request, for a small charge.

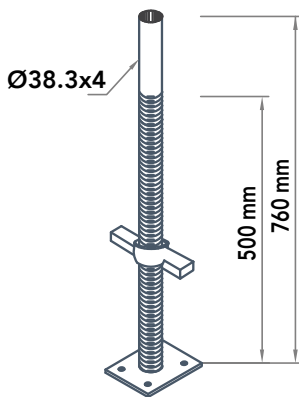

BASE JACK

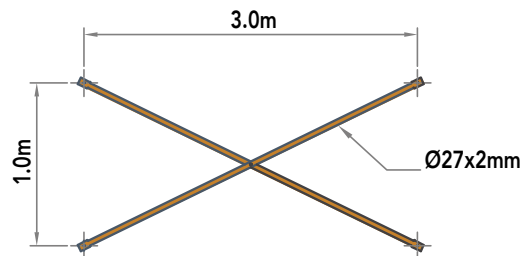

DIAGONAL BRACE

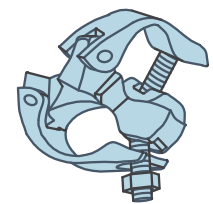

DOUBLE COUPLER

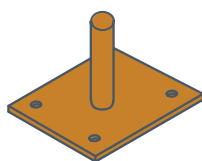

PLAIN BASE PLATE

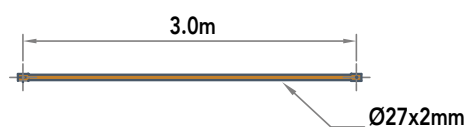

HORIZONTAL BRACE

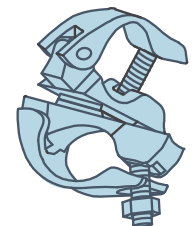

SWIVEL COUPLER

Detailed catalogue of Frames, Props and Tubes available on request

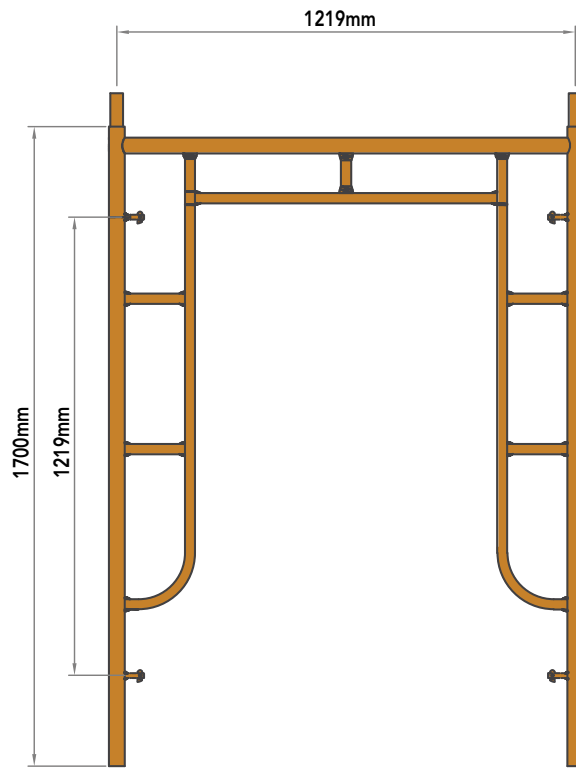

BEATTY FRAME

VERTICAL TUBES OF THE FRAME ARE MADE OF $\text{Ø}42.9 \times 2 \text{MM}$ TUBE

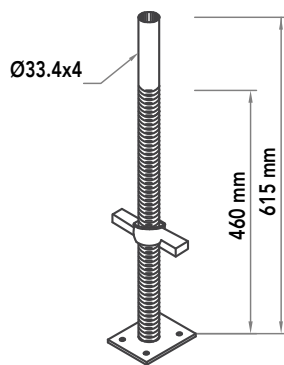

BASE JACK

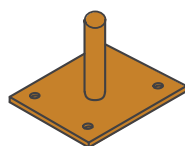

PLAIN BASE PLATE

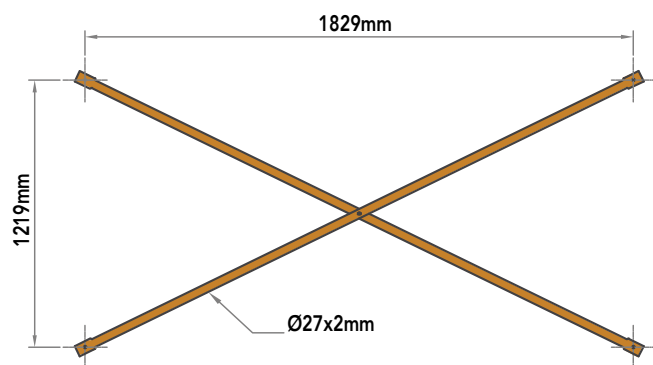

CROSS BRACE