



**K H K SCAFFOLDING
& FORMWORK L.L.C.**

Table FORMWORK



K-Load Table Formwork

K-Load Frames

Suitable for different kinds of building structures, frames are connected by cross braces to make different sizes of table based on the slab thickness

Allowable load data contain there in has been developed through the use of test procedure recommended by the "scaffolding and shoring institute" and a safety factor of 2.5 to 1.

Capacity: per leg 60kN

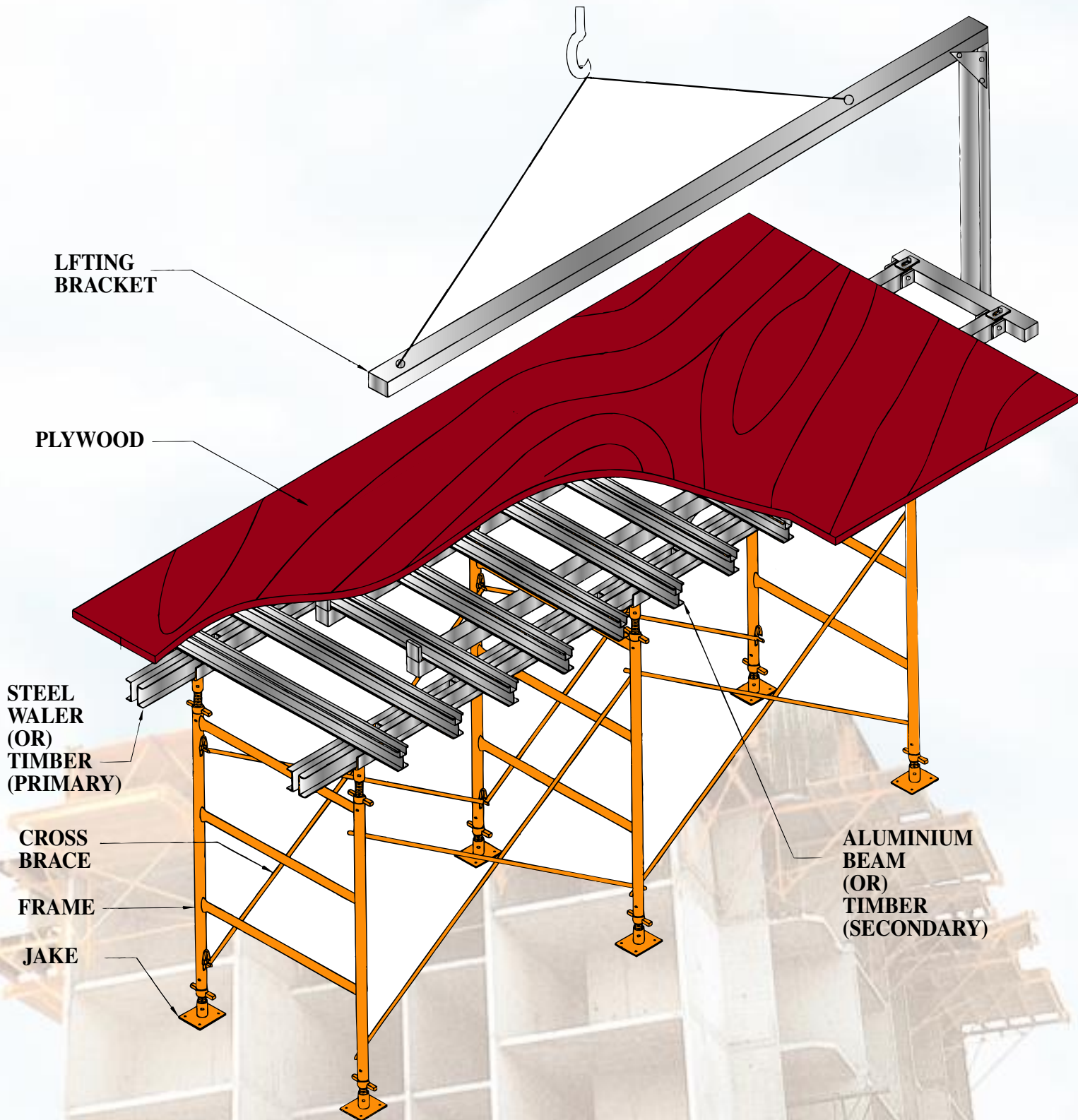

K-Load Table Formwork

Hi-Load Frames

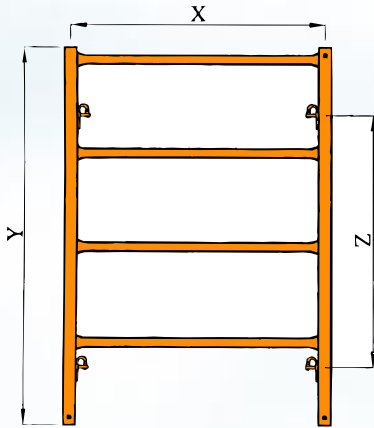

Size 'X'	Size 'Y'	Size 'Z'	Weight (kg.)
4'0"	6'0"	4'0"	30.4
4'0"	5'0"	4'0"	24.5
4'0"	4'0"	3'0"	20.9
4'0"	3'0"	2'0"	15.5
2'0"	6'0"	4'0"	26.3
2'0"	5'0"	4'0"	20.4
2'0"	4'0"	3'0"	16.8
2'0"	3'0"	2'0"	11.3

Hi-Load Cross Brace (Angle)

Size 'X'	Size 'Y'	Size 'Z'	Weight (kg.)
4'0"	4'0"	3'0"	5.0
5'0"	4'0"	3'0"	6.0
6'0"	4'0"	3'0"	6.8
7'0"	4'0"	3'0"	7.6
8'0"	4'0"	3'0"	8.4
10'0"	4'0"	3'0"	10.0

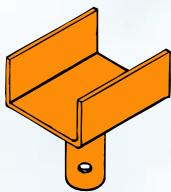
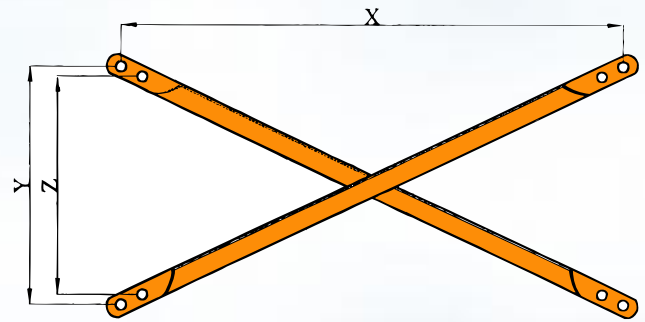

U-Head

Available Sizes

4" x 8"

5" x 8"

8" x 8"

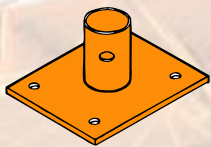

BASE PLATE



CONNECTING PIN Ø 16mm

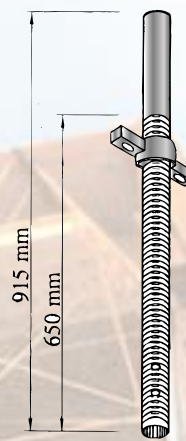

JACK

CONNECTOR



TROLLEY

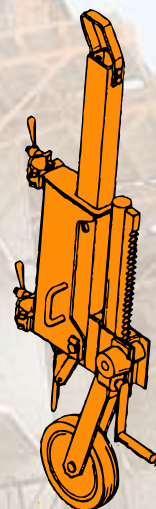

LIFTING CLAMP



LIFTING PIN Ø 10mm



K H K SCAFFOLDING & FORMWORK L.L.C.

Head Office:

New Industrial Area
P.O.Box: 2701, Ajman-U.A.E
Tel: +971-6-7439013, Fax: +971-6-7439017
E-mail: khkscaf@emirates.net.ae, Website: www.khk-scaffolding.com

Branches :

A-Val Metal Resources, Inc.

5925, Airport Road, Suite 200, Airway Centre,
Mississauga L4V 1W1, Ontario, Canada
Tel.: 001 905 405 6245, Fax: 001 905 672 8630
email : khk@avalmetal.com or hasiha@khk-scaffolding.com

Brisko Scaffolding Limited

120 South lane New Malden
Surrey KT3 SEL England
Tel.: 0044 - 20 - 83364595
Fax: 0044 - 20 - 83364596

Prime Metal CORPORATION - USA

653 Route 52, Walden NY 12586
United States of America
Tel.: 001 - 845 - 778 4545
Fax: 001 - 845 - 778 4218

Winston Scaffolding Pty Ltd.

44-46 Gould Street
South Strathfield, N.S.W. 2136
Tel.: 00 - 02 - 97588700
Fax: 00 - 02 - 97587263

