

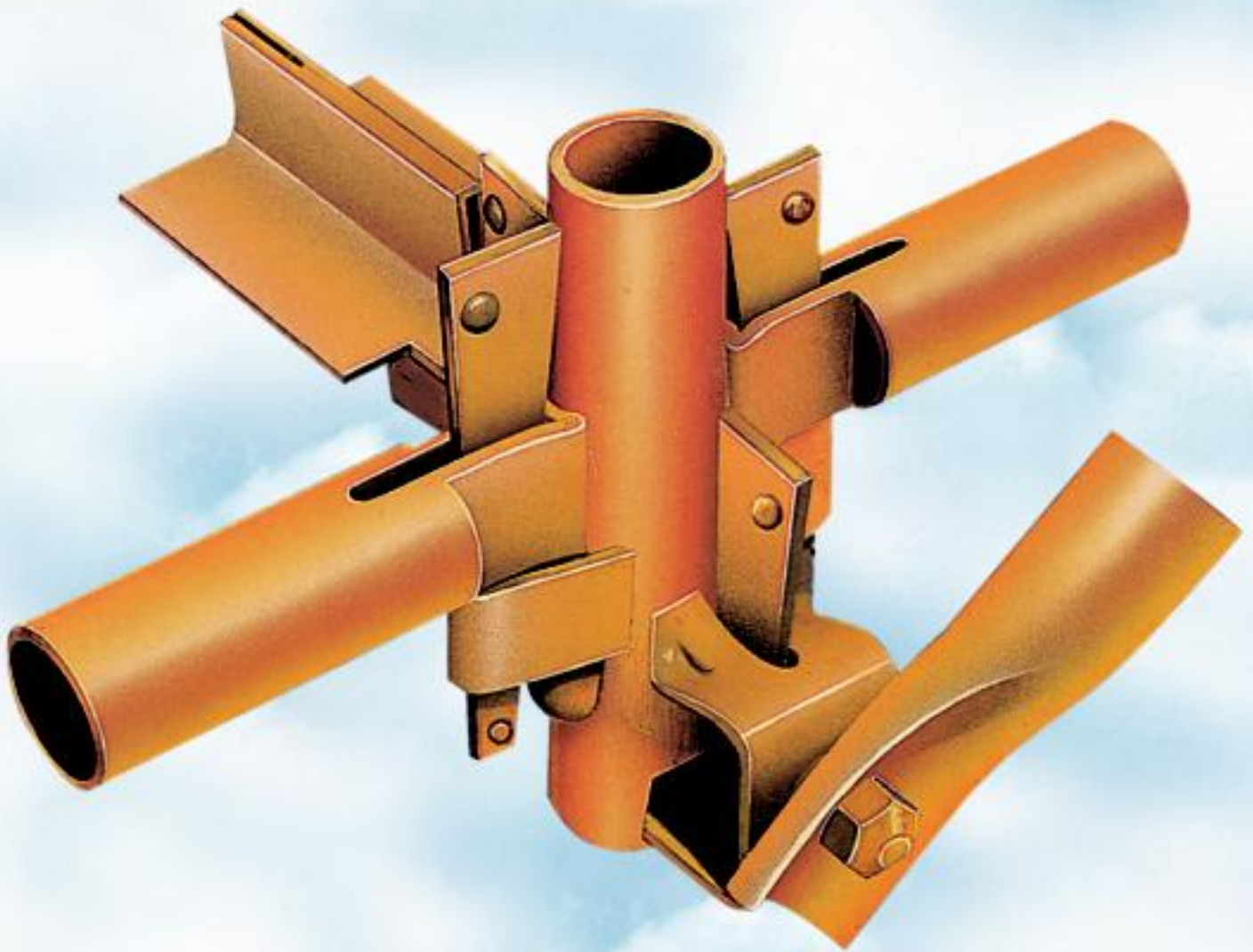

**K H K SCAFFOLDING
& FORMWORK L.L.C.**

K-Stage Access Scaffold



K-Stage Access Scaffold

K-Stage Access Scaffold

- K-STAGE is a modular system scaffold with wedge fixing for all access scaffold requirements.
- The wedge fixing of the ledgers and transoms gives a simple and fast means of erecting access scaffolding without loose parts.
- Rigid 4 way fixing gives a positive location without movement.
- Spigot and wedge fitting on the standard to give guaranteed vertical alignment.
- Quality primed & painted or hot dipped galvanised finish for maintenance free use.
- Conforms to BS1139 Part 5, HD 1000, OSHA, Australian, New Zealand Standards.

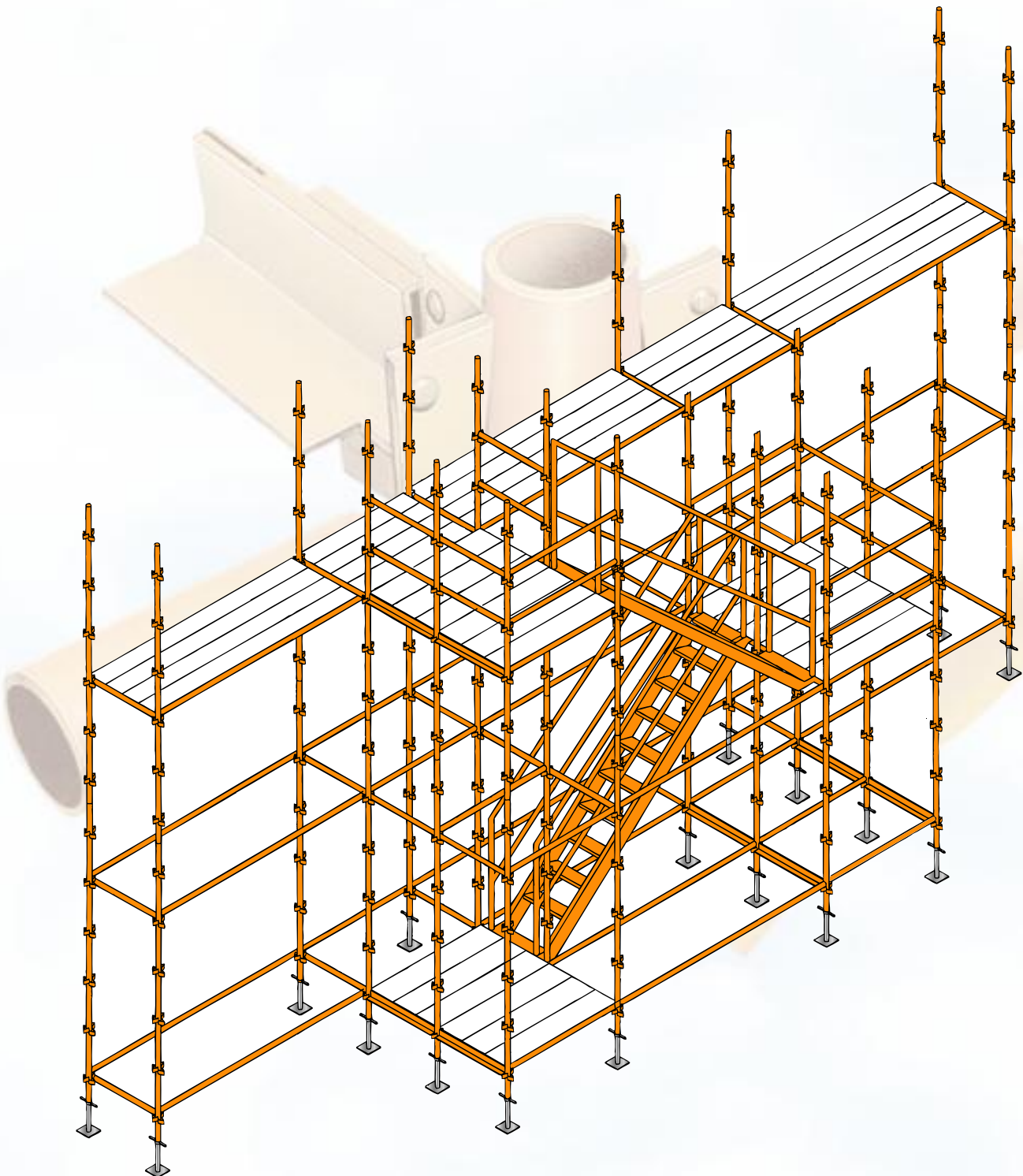

K-Stage Access Scaffold

K-Stage Access Scaffold Components

Hop Up Bracket

To extend the scaffold by cantilevering for an additional 1, 2 or 3 board platform.

Description	Weight (kg)
1 Board Hop Up Bracket	2.3
2 Board Hop Up Bracket	5.8
3 Board Hop Up Bracket	9.5

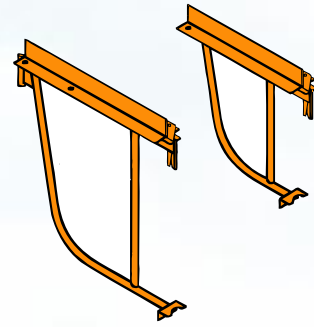

Toe Board Bracket

Clamps to the standard with a captive wedge to hold the batten toe board vertically in place.

Description	Weight (kg)
Toe Board Bracket	0.78

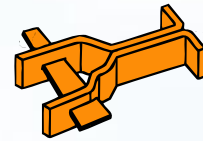

End Toe Board Bracket

Fits into 'V' locating lugs on the standard at the end of a platform to hold the end batten toe board vertically in place.

Description	Weight (kg)
End Toe Board Bracket	1.18



Tie Bar

For connecting the access brackets along the length of the platform. This ensures correct spacing so that the battens are not dislodged.

Description	Weight (kg)
8'0" Tie Bar	7.0
6'0" Tie Bar	5.2
4'2" Tie Bar	3.5



Batten

The steel platform batten spans between the transoms giving a non-slip level surface.

Description	Weight (kg)
8'0" Steel Batten	14.8
6'0" Steel Batten	12.8
4'2" Steel Batten	10.9

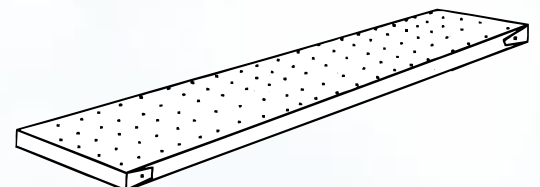

K-Stage Access Scaffold

K-Stage Access Scaffold Components

Batten Clamp

To secure battens in high wind conditions.

Description	Weight (kg)
Batten Clamp	3.25

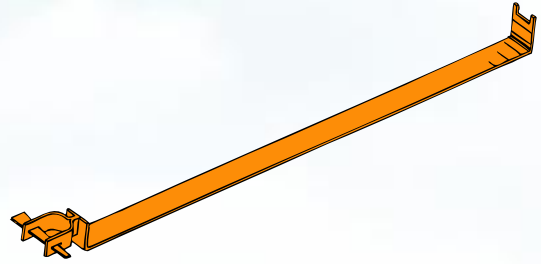

Internal Corner Filler

For use with two and three board stage bracket, to fill the gap at internal corners.

Description	Weight (kg)
3' x 3' Corner Filler	11.2
3' x 5' Corner Filler	15.1

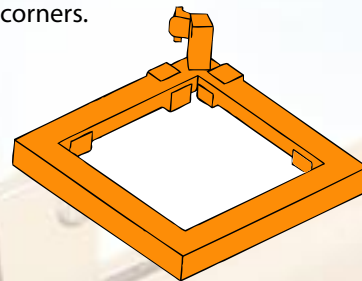

Bridging Ledger 16'0"

Made from standard tube to span between two 8' bays to give clear access or to avoid obstructions.

Description	Weight (kg)
16'0" Bridging Ledger	32.0



Bridging Ledger 24'0"

Made from standard tube to span between three 8' bays to give clear access or to avoid obstructions.

Description	Weight (kg)
24'0" Bridging Ledger	57.0



K-Stage Access Scaffold

K-Stage Access Scaffold Components

Return Transom

Fixed to the inner and outer standard and placed over the first ledger of an adjacent 90° bay. Seating on one side for 3 or 5 numbers of steel or timber battens giving the same level decking on both scaffold runs.

Description	Weight (kg)
4'2" Return Transom	13.4
2'8" Return Transom	8.8
2'6" Return Transom	8.4

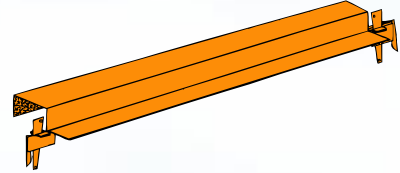

Diagonal Brace

The diagonal brace is used to the full height of the scaffolding in a longitudinal direction.

Description	Weight (kg)
12'0" (8' x 8'1 1/2" Bay)	13.4
9'0" (6' x 6'6" Bay)	10.6
6'0" (4'2" x 4'10 1/2" Bay)	8.0
8' x 6'6" Bay	11.9

Other sizes are available on request.

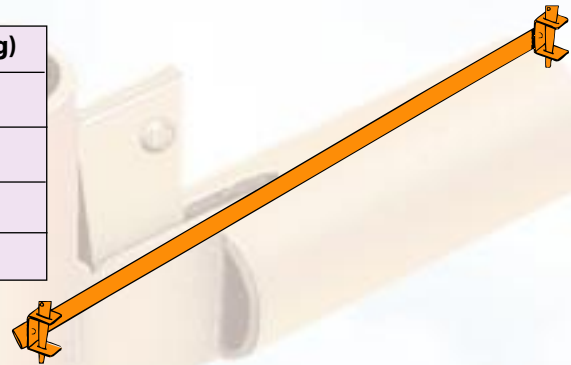

Coupler Brace

The coupler brace is used when necessary across the scaffold.

Description	Weight (kg)
8' x 6'6" Bay	12.1
6' x 6'6" Bay	10.7

Other sizes are available on request.



Stage Bracket

To extend the scaffold by cantilevering for an additional 1,2 or 3 board platform.

Description	Weight (kg)
1 Board Stage Bracket	2.3
2 Board Stage Bracket	5.8
3 Board Stage Bracket	9.5

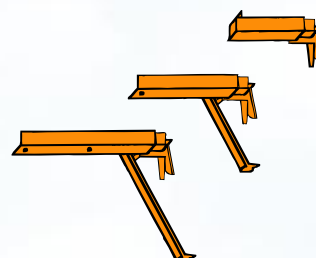

K-Stage Access Scaffold

K-Stage Access Scaffold Components

Standards

The standard is the vertical member of the scaffold with a spigot (either round or box type) at one end for accurate alignment.

A series of 'V' locating lugs are welded on the tube for the attachment of ledgers, transoms, and auxiliary components.

Open ended standards and loose spigots are also available.

Description	Weight (kg)
9'9" Standard	17.4
8'1.5" Standard	15.0
6'6" Standard	12.3
4'10.5" Standard	9.4
3'3" Standard	6.4
1'7.5" Standard	3.6

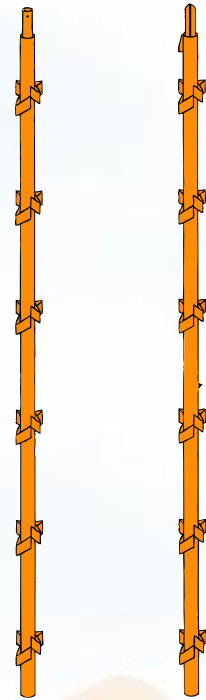

Ledgers

The ledger is used to connect the standard in a longitudinal direction. It is made from scaffold tube with wedge 'Banana Type' fixing at each end which fits in the 'V' locating lugs on the standard. The ledger is also used as a guardrail.

Description	Weight (kg)
8'0" Ledger	11.0
6'0" Ledger	8.3
4'2" Ledger	5.9
2'8" Ledger	3.9
2'6" Ledger	3.7



Transom

Transom is either made of back-to-back angle or T-shaped profile with the same fixing device on each end as the ledger. They are used to carry 3 or 5 numbers of steel or timber battens and toeboard.

Description	Weight (kg)
4'2" Transom	9.6
2'8" Transom	5.9
2'6" Transom	5.5

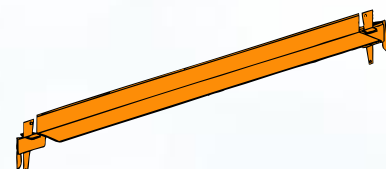

K-Stage Access Scaffold

K-Stage Access Scaffold Components

Flat Bar Transom

Description	Weight (kg)
8'0" Flat Bar Transom	23.5
6'0" Flat Bar Transom	14.0

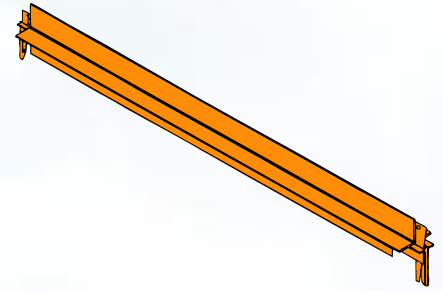

Bow String Transom

Description	Weight (kg)
8'0" Bow String Transom	21.5

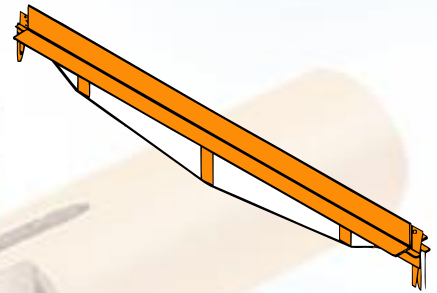

Loading Bay Transom

Description	Weight (kg)
8'0" Loading Bay Transom	27.8



Ladder Access Transom

Used to secure the ladder to the system

Description	Weight (kg)
6'0" Ladder Access Transom	13.0
4'2" Ladder Access Transom	9.2

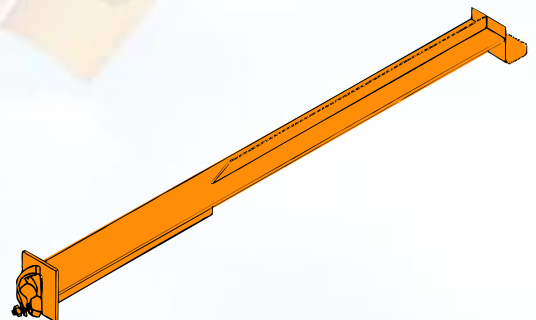

K-Stage Access System

Ladder Access

Ladder

Three different sizes of ladder are available which can be connected to obtain any length.

Description	Weight (kg)
3.0m Ladder	24.0
1.5m Ladder	12.6
1.0m Ladder	8.9

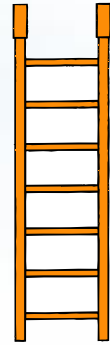

Ladder Access Transom

Used to secure the ladder to the system.

Description	Weight (kg)
6'0" Ladder Access Transom	13.0
4'2" Ladder Access Transom	9.2

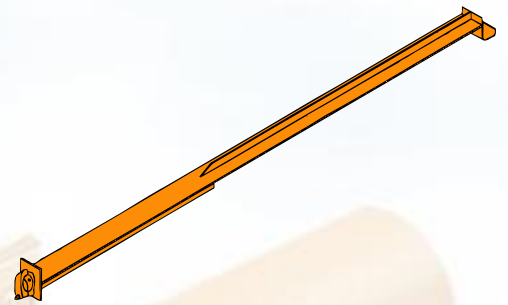

Stair Access

Description	Weight (kg)
Stair Case (8' x 6'6")	33
Outer Hand Rail	14
Inner Hand Rail	11

Outer Handrail

Inner Handrail

Stair Case

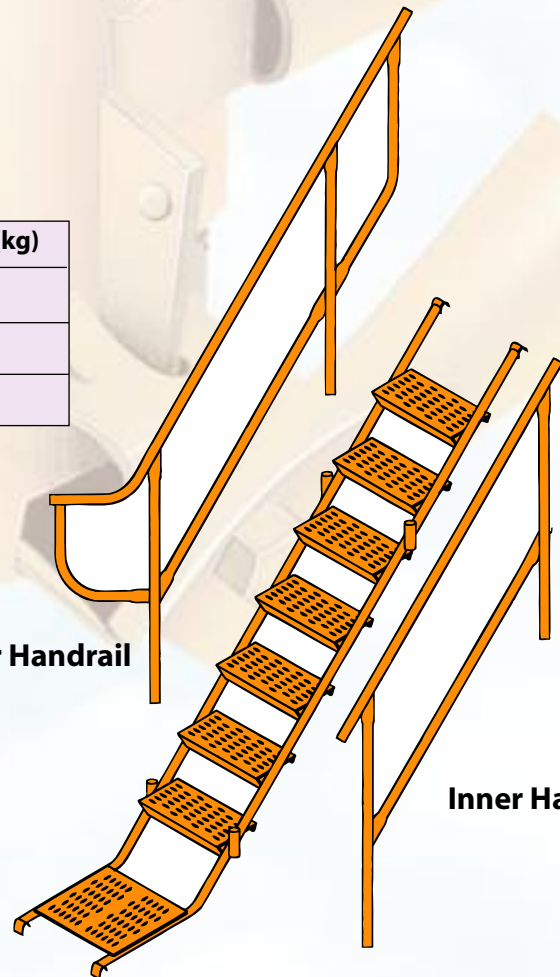

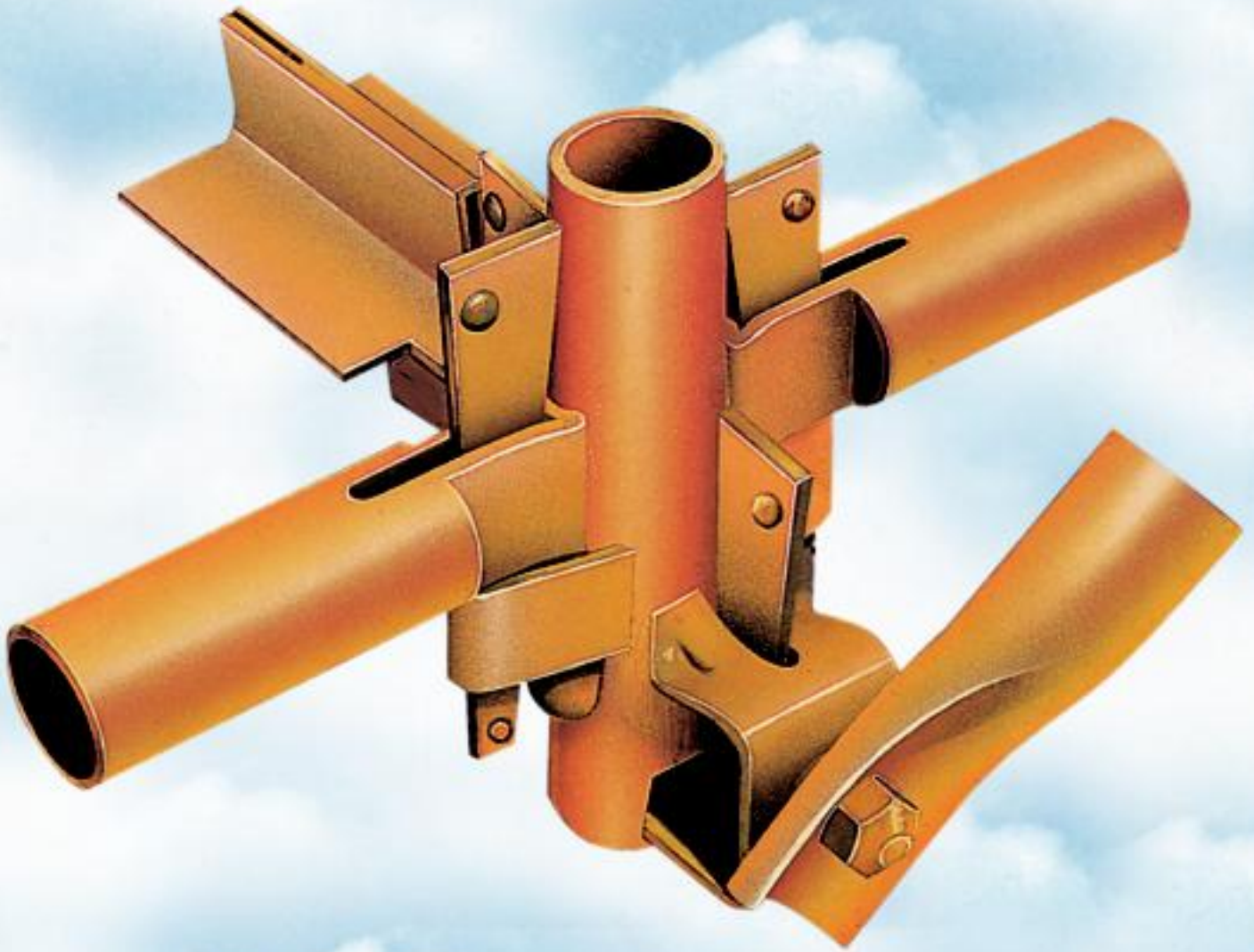

 **K H K SCAFFOLDING**
& FORMWORK L.L.C.

Head Office:

New Industrial Area

P.O.Box: 2701, Ajman-U.A.E

Tel: +971-6-7439013, Fax: +971-6-7439017

E-mail: khkscaf@emirates.net.ae, Website: www.khk-scaffolding.com

Branches :

A-Val Metal Resources, Inc.

5925, Airport Road, Suite 200, Airway Centre,
Mississauga L4V 1W1, Ontario, Canada

Tel.: 001 905 405 6245, Fax: 001 905 672 8630

email : khk@avalmetal.com or hasiha@khk-scaffolding.com

Brisko Scaffolding Limited

120 South lane New Malden
Surrey KT3 SEL England

Tel.: 0044 - 20 - 83364595

Fax: 0044 - 20 - 83364596

Prime Metal CORPORATION - USA

653 Route 52, Walden NY 12586

United States of America

Tel.: 001 - 845 - 778 4545

Fax: 001 - 845 - 778 4218

Winston Scaffolding Pty Ltd.

44-46 Gould Street

South Strathfield, N.S.W. 2136

Tel.: 00 - 02 - 97588700

Fax: 00 - 02 - 97587263